

## 3120-F321-P7T1-W14FR3-2.5A

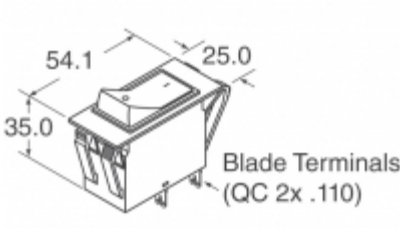

Obrázky jsou pouze orientační.  
Podrobné informace o produktu naleznete v části Technické údaje produktu.  
**Koupit 3120-F321-P7T1-W14FR3-2.5A s důvěrou od Component-World.HK, 1 rok záruka**



**Part Number:** [3120-F321-P7T1-W14FR3-2.5A](#)

**Výrobce:** [E-T-A](#)

**Popis:** CIR BRKR THRM 2.5A 250VAC 50VDC

**Datový list:**  [3120-F Series Datasheet](#)

**RoHS Status:** Bez olova / V souladu RoHS

**Ship From:** Hong Kong

**Shipment Way:** DHL/Fedex/TNT/UPS/EMS

[Request For Quotation](#)







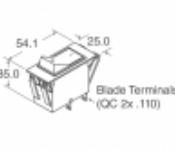
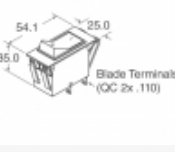
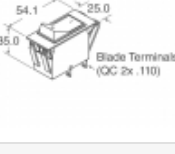

### PARAMETR PRODUKTU

<b>Part Number</b>	3120-F321-P7T1-W14FR3-2.5A	<b>Výrobce</b>	<a href="#">E-T-A</a>
<b>Popis</b>	CIR BRKR THRM 2.5A 250VAC 50VDC	<b>Stav volného vedení / RoHS</b>	Bez olova / V souladu RoHS
<b>Dostupné množství</b>	2200 pcs	<b>Datový list</b>	<a href="#">3120-F Series Datasheet</a>
<b>Kategorie</b>	<a href="#">Ochrana obvodu</a>	<b>Napítí - DC</b>	50V
<b>Napítí - AC</b>	250V	<b>Série</b>	3120-F
<b>Ostatní jména</b>	3120-F321-P7T1-W14FR3-2.5AMP	<b>Počet pólů</b>	2
<b>Typ montáže</b>	Panel Mount	<b>Výrobní standardní doba výroby</b>	9 Weeks
<b>Stav volného vedení / RoHS</b>	Lead free / RoHS Compliant	<b>Osvětlení napětí (nominální)</b>	90V
<b>Osvětlení</b>	Red	<b>Jmenovitá hodnota proudu</b>	2.5A
<b>Breaker Typ</b>	Thermal	<b>Pohon Type</b>	Rocker

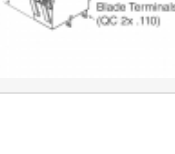
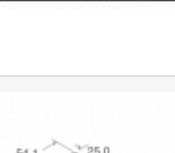
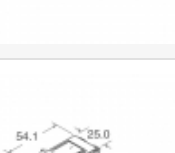
Component-World.com je spolehlivý distributor elektronických součástek. Specializujeme se na všechny elektronické komponenty řady E-T-A. Máme 2200 kusy E-T-A 3120-F321-P7T1-W14FR3-2.5A na skladě dostupných. Vyžádejte si citát z distributora součástí elektroniky na Component-World.com, náš prodejní tým vás bude kontaktovat do 24 hodin.

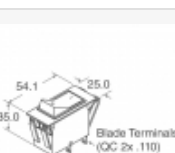
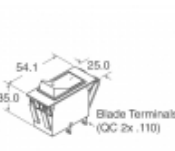
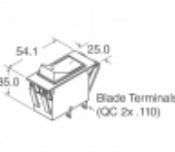
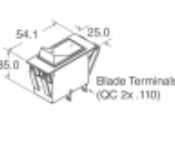
RFQ Email: [info@Components-World.com](mailto:info@Components-World.com)

### SOUVISEJÍCÍ PRODUKTY

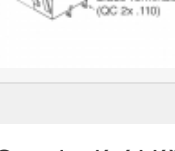
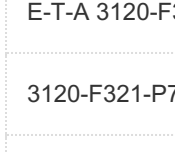
	<b>Část#:</b> <a href="#">3120-F321-P7T1-W14FR3-12A</a>	<b>Výrobci:</b> <a href="#">E-T-A</a>	<a href="#">Dotaz</a>
	<b>Popis:</b> CIR BRKR THRM 12A 250VAC 50VDC		
	<b>Část#:</b> <a href="#">3120-F321-P7T1-W14FR4-20A</a>	<b>Výrobci:</b> <a href="#">E-T-A</a>	<a href="#">Dotaz</a>
	<b>Popis:</b> CIR BRKR THRM 20A 250VAC 50VDC		
	<b>Část#:</b> <a href="#">3120-F321-P7T1-W14FR3-10A</a>	<b>Výrobci:</b> <a href="#">E-T-A</a>	<a href="#">Dotaz</a>
	<b>Popis:</b> CIR BRKR THRM 10A		
	<b>Část#:</b> <a href="#">3120-F321-P7T1-W14FR4-10A</a>	<b>Výrobci:</b> <a href="#">E-T-A</a>	<a href="#">Dotaz</a>
	<b>Popis:</b> CIR BRKR THRM 10A 250VAC 50VDC		
	<b>Část#:</b> <a href="#">3120-F321-P7T1-W14FR3-16A</a>	<b>Výrobci:</b> <a href="#">E-T-A</a>	<a href="#">Dotaz</a>
	<b>Popis:</b> CIR BRKR THRM 16A 250VAC 50VDC		
	<b>Část#:</b> <a href="#">3120-F321-P7T1-W14FR4-2.5A</a>	<b>Výrobci:</b> <a href="#">E-T-A</a>	<a href="#">Dotaz</a>
	<b>Popis:</b> CIR BRKR THRM 2.5A 250VAC 50VDC		
	<b>Část#:</b> <a href="#">3120-F321-P7T1-W14DR9-20A</a>	<b>Výrobci:</b> <a href="#">E-T-A</a>	<a href="#">Dotaz</a>
	<b>Popis:</b> CIRC BRKR THRM		
	<b>Část#:</b> <a href="#">3120-F321-P7T1-W14FR1-16A</a>	<b>Výrobci:</b> <a href="#">E-T-A</a>	<a href="#">Dotaz</a>
	<b>Popis:</b> CIR BRKR THRM 16A 250VAC 50VDC		
	<b>Část#:</b> <a href="#">3120-F321-P7T1-W14FB3-2.5A</a>	<b>Výrobci:</b> <a href="#">E-T-A</a>	<a href="#">Dotaz</a>
	<b>Popis:</b> CIR BRKR THRM 2.5A 250VAC 50VDC		
	<b>Část#:</b> <a href="#">3120-F321-P7T1-W14FR3-5A</a>	<b>Výrobci:</b> <a href="#">E-T-A</a>	<a href="#">Dotaz</a>
	<b>Popis:</b> CIR BRKR THRM 5A 250VAC 50VDC		
	<b>Část#:</b> <a href="#">3120-F321-P7T1-W14DR4-5A</a>	<b>Výrobci:</b> <a href="#">E-T-A</a>	<a href="#">Dotaz</a>
	<b>Popis:</b> CIRC BRKR THRM		
	<b>Část#:</b> <a href="#">3120-F321-P7T1-W14FR3-3A</a>	<b>Výrobci:</b> <a href="#">E-T-A</a>	<a href="#">Dotaz</a>
	<b>Popis:</b> CIR BRKR THRM 3A 250VAC 50VDC		
	<b>Část#:</b> <a href="#">3120-F321-P7T1-W14HR4-3A</a>	<b>Výrobci:</b> <a href="#">E-T-A</a>	<a href="#">Dotaz</a>
	<b>Popis:</b> CIR BRKR THRM 3A 250VAC 50VDC		
	<b>Část#:</b> <a href="#">3120-F321-P7T1-W14FR4-16A</a>	<b>Výrobci:</b> <a href="#">E-T-A</a>	<a href="#">Dotaz</a>
	<b>Popis:</b> CIR BRKR THRM 16A 250VAC 50VDC		
	<b>Část#:</b> <a href="#">3120-F321-P7T1-W14FR3-1A</a>	<b>Výrobci:</b> <a href="#">E-T-A</a>	<a href="#">Dotaz</a>
	<b>Popis:</b> CIR BRKR THRM 1A 250VAC 50VDC		
	<b>Část#:</b> <a href="#">3120-F321-P7T1-W14FR3-8A</a>	<b>Výrobci:</b> <a href="#">E-T-A</a>	<a href="#">Dotaz</a>
	<b>Popis:</b> CIR BRKR THRM 8A 250VAC 50VDC		
	<b>Část#:</b> <a href="#">3120-F321-P7T1-W14FR3-1.5A</a>	<b>Výrobci:</b> <a href="#">E-T-A</a>	<a href="#">Dotaz</a>
	<b>Popis:</b> CIR BRKR THRM 1.5A 250VAC 50VDC		
	<b>Část#:</b> <a href="#">3120-F321-P7T1-W14FR3-2A</a>	<b>Výrobci:</b> <a href="#">E-T-A</a>	<a href="#">Dotaz</a>
	<b>Popis:</b> CIR BRKR THRM 2A		
	<b>Část#:</b> <a href="#">3120-F321-P7T1-W14FR3-0.5A</a>	<b>Výrobci:</b> <a href="#">E-T-A</a>	<a href="#">Dotaz</a>
	<b>Popis:</b> CIR BRKR THRM 500MA 250VAC 50VDC		
	<b>Část#:</b> <a href="#">3120-F321-P7T1-W14LR4-1.5A</a>	<b>Výrobci:</b> <a href="#">E-T-A</a>	<a href="#">Dotaz</a>
	<b>Popis:</b> CIR BRKR THRM 1.5A 250VAC 50VDC		

### Související klíčová slova pro 3120-F321-P7T1-W14FR3-2.5A

E-T-A 3120-F321-P7T1-W14FR3-2.5A.	3120-F321-P7T1-W14FR3-2.5A distributor	3120-F321-P7T1-W14FR3-2.5A dodavatel	3120-F321-P7T1-W14FR3-2.5A Cena
3120-F321-P7T1-W14FR3-2.5A Stáhnout datasheet.	3120-F321-P7T1-W14FR3-2.5A Datasheet.	3120-F321-P7T1-W14FR3-2.5A Stock.	koupit 3120-F321-P7T1-W14FR3-2.5A.
E-T-A 3120-F321-P7T1-W14FR3-2.5A.			